



BR / BR 70 / BRS-F

Optimale Lösungen für industrielle Beleuchtung und Leitungsführung – sowohl im Elektroinstallationshandwerk, als auch im Maschinen- und Schaltschrankbau.

Diesem Anspruch wird LICATEC als inhabergeführtes mittelständisches Unternehmen mit hoher Flexibilität und kurzen Entscheidungswegen schon seit mehr als 40 Jahren gerecht.

Wir entwickeln und produzieren innovative und montagefreundliche Systeme, um unseren Kunden die Arbeit zu erleichtern.

Über unser gut ausgebautes internationales Vertriebsnetz gewährleisten wir die kompetente Beratung vor Ort, unsere Zentrallogistik sichert die schnelle und termingerechte Belieferung, oft bis direkt auf die Baustelle.

Weltweit vertrauen, mit weiterhin stark steigender Tendenz, bereits mehr als 5000 Kunden unseren Produkten und unserem Service – für uns ein großer Ansporn, den eingeschlagenen Weg konsequent weiter zu verfolgen.

Alle technischen Daten, Abbildungen und Preisangaben wurden sorgfältig erstellt. Irrtümer vorbehalten. Technische Änderungen, die der Weiterentwicklung dienen, behalten wir uns vor. Alle Maßangaben sind in mm.

Unsere Lieferungs- und Zahlungsbedingungen finden Sie im Internet unter www.licatec.de/agb.

The provision of optimal solutions for industrial lighting and cable conduit systems – both in the electrical installation trade as well as in mechanical engineering and switch cabinet construction.

The owner-managed medium-sized company LICATEC has been meeting these requirements for more than 40 years with its high degree of flexibility and short decision-making paths.

We develop and produce innovative and easy to install systems which make our client's work easier.

Our well-developed international sales network enables us to guarantee competent local advice and our central logistics secures the fast on time delivery, often onto the construction site.

More than 5000 customers world wide place their trust in our products and our service, and that with a growing tendency – this is a great motivation for us to consistently continue along this road.

All technical data and illustrations have been prepared with care. Errors excepted. We reserve the right to make any technical modifications which serve further development. All dimensions are in mm.

Please see www.licatec.de/agb for reference regarding our Terms of Delivery and Payment.

Inhalt



BR / BR 70, Hart-PVC / BR / BR 70 rigid PVC	4 - 7
BRS-F, Stahlblech / BRS-F, made of sheet steel	8 - 11
Allgemeines Zubehör / General Accessories	12
BR / BR 70 Zubehör / BR / BR 70 Accessories	13
BRS-F Zubehör / BRS-F Accessories	14 - 15

BR, Hart-PVC / BR rigid PVC

Brüstungskanäle aus Hart-PVC / Undersill Trunkings, rigid PVC

VDE   RoHS konform / compliant

Lieferbar bis
31.12.2011!
Danach nur
noch auf
Anfrage

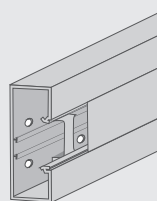
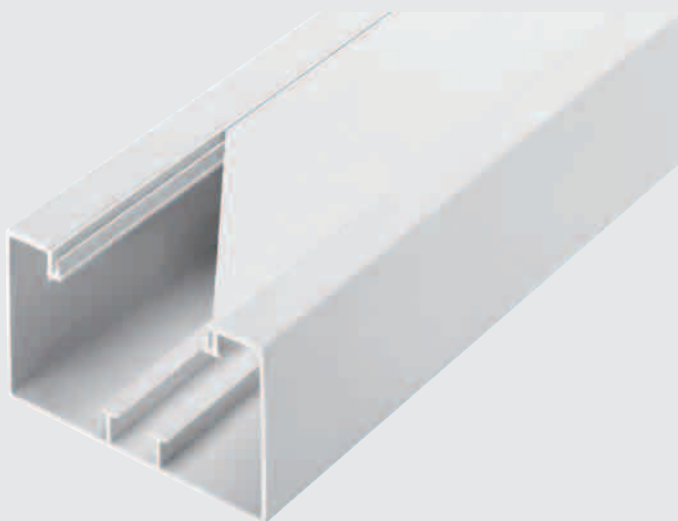

130 x 65

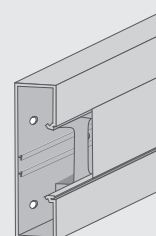

170 x 65

Material: Hart-PVC, schwer entflammbar, selbstverlöschend

Deckelöffnung: 76 mm

- Farben: weiß RAL 9001, reinweiß RAL 9010, lichtgrau RAL 7035
- Lieferumfang: Unterteil und Formteile mit Bodenlochungen (Abstand 125 mm) und Schutzfolie, inkl. Deckel, Länge 2 m

Material: Rigid PVC, hardly-inflammable, self-extinguishing

Cover opening: 76 mm

- Colours: white RAL 9001, pure white RAL 9010, light grey RAL 7035
- Extent of supply: base and fittings with perforated bottom (distance 125 mm) and protection foil, incl. cover, length 2 m

Klammer / Clamp



Typ Type	Deckelöffnung / Cover opening	Artikel-Nr. Article-No.
65/70	76 mm	8180

Wandanschlussblende / Wallcover



Typ Type	Farbe / Colour	Artikel-Nr. Article-No.
130/65	RAL 9001	8090
130/65	RAL 9010	8095
170/65	RAL 9001	8187
170/65	RAL 9010	8186

Farbe Colour	Abmessungen Dimensions B x H / W x H	Länge Length	VE PU	Artikel-Nr. Article-No.	Artikel-Nr. / Article-No.				
					Außeneck Outside Corner	Inneneck Inside Corner	Flachwinkel Flat Corner	T-Stück T-piece	Endstück End Cap
RAL 9001	130 x 65	2 m	8	8000	8010	8020	8040	8080	8030
RAL 7035	130 x 65	2 m	8	8004	8014	8024	8044	8084	8034
RAL 9010	130 x 65	2 m	8	8005	8015	8025	8045	8085	8035
RAL 9001	170 x 65	2 m	8	8107	8117	8127	8147	8157	8130
RAL 7035	170 x 65	2 m	8	8104	8114	8124	8144	8154	8134
RAL 9010	170 x 65	2 m	8	8106	8116	8126	8146	8156	8135

Symbolische Darstellungen:

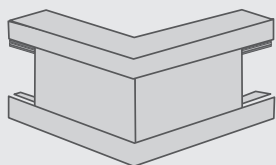

Außenecken
Outside Corners

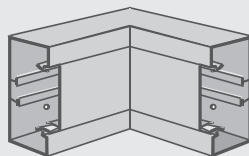

Innenecken
Inside Corners

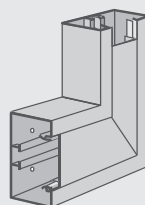

Flachwinkel
Flat Corners

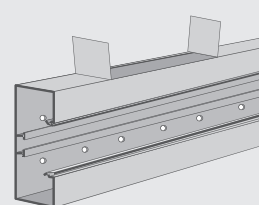

T-Stücke
T-pieces

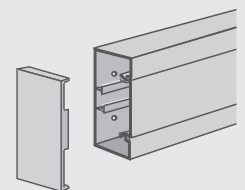

Endstücke
End Caps

Stoßverbinder innen / Couplers, internal

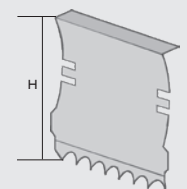

Typ Type	H	Material	Pro Stoßstelle benötigt / Per joint required	VE PU	Artikel-Nr. Article-No.
Bauhöhe 61 / installation height 61	61	Federstahl / spring steel	2 Stück / pieces	20	30052

BR 70, Hart-PVC / BR 70 rigid PVC

Brüstungskanäle aus Hart-PVC / Undersill Trunkings, rigid PVC

VDE   RoHS konform / compliant

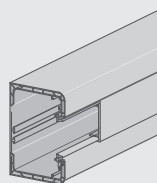
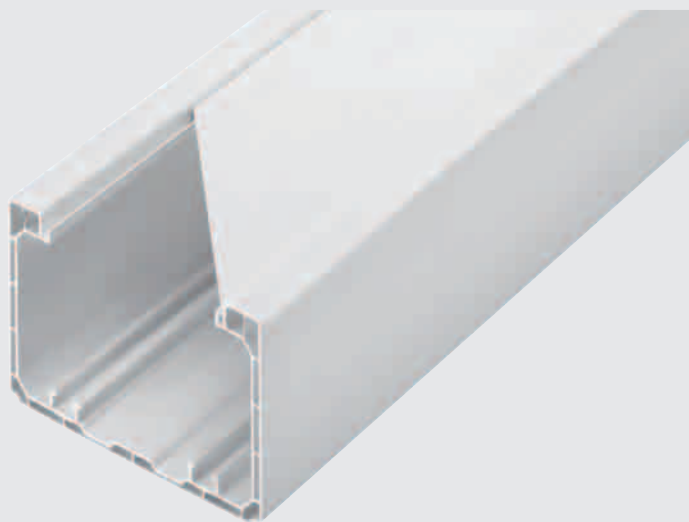

110 x 70

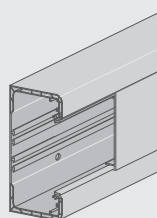

170 x 70

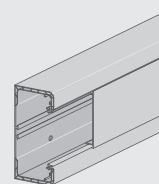

130 x 70

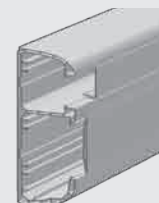

210 x 70

Material: Hart-PVC, schwer entflammbar, selbstverlöschend

Deckelöffnung: 76 mm

Besondere Merkmale:

- Farben: weiß RAL 9001, reinweiß RAL 9010
- Lieferumfang: Unterteil und Formteile mit Bodenlochungen (Abstand 125 mm) und Schutzfolie, inkl. Deckel, Länge 2 m

Material: Rigid PVC, hardly-inflammable, self-extinguishing

Cover opening: 76 mm

Specific Features:

- Colours: white RAL 9001, pure white RAL 9010
- Extent of supply: base and fittings with perforated bottom (distance 125 mm) and protection foil, incl. cover, length 2 m

Verbinder für BR für 110/210 x 70 / Couplers for BR for 110/210 x 70



Typ Type	Farbe Colour	Artikel-Nr. Article-No.
110/70	RAL 9010	8655
210/70	RAL 9010	8755

Wandanschlussblende / Wallcover



Typ Type	Farbe Colour	Artikel-Nr. Article-No.
110/70	RAL 9010	8695
130/70	RAL 9001	8290
130/70	RAL 9010	8295
170/70	RAL 9001	8590
170/70	RAL 9010	8595
210/70	RAL 9010	8795

Farbe Colour	Abmessungen Dimensions B x H / W x H	Länge Length	VE PU	Artikel-Nr. Article-No.	Artikel-Nr. / Article-No.				
					Außeneck Outside Corner	Inneneck Inside Corner	Flachwinkel Flat Corner	T-Stück T-piece	Endstück End Cap
RAL 9010	110 x 70	2 m	6	8605	8615	8625	8645	8685	8635
RAL 9001	130 x 70	2 m	12	8200	8210	8220	8240	8250	8230
RAL 9010	130 x 70	2 m	12	8205	8215	8225	8245	8255	8235
RAL 9001	170 x 70	2 m	12	8500	8510	8520	8540	8550	8530
RAL 9010	170 x 70	2 m	12	8505	8515	8525	8545	8555	8535
RAL 9010	210 x 70	2 m	6	8705	8715	8725	8745	8785	8735

Symbolische Darstellungen:

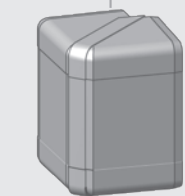

Außenecken
Outside Corners

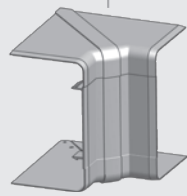

Innenecken
Inside Corners

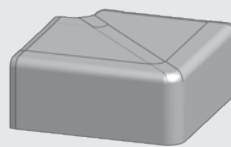

Flachwinkel
Flat Corners

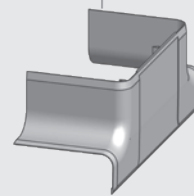

T-Stücke
T-pieces

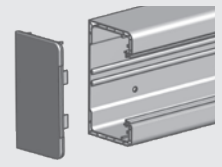

Endstücke
End Caps

Klammer / Clamp

für 130 und 170/70 / for 130 and 170/70



Typ Type	Deckelöffnung / Cover opening	Artikel-Nr. Article-No.
65/70	76 mm	8180

T-Adapter / T-Adaptor

für 130 und 170/70 / for 130 and 170/70

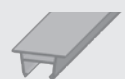

Typ Type	Länge Length	Artikel-Nr. Article-No.
T 70	300 mm	8820

Stoßverbinder innen / Couplers, internal

für 130 und 170/70 / for 130 and 170/70



Typ Type	H	Material	Pro Stoßstelle benötigt Per joint required	VE PU	Artikel-Nr. Article-No.
Bauhöhe 70 / installation height 70	70	PC / ABS	2 Stück / pieces	10	8810

BRS-F, Stahlblech / BRS-F, made of sheet steel

Brüstungskanäle aus Stahlblech / Undersill Trunkings, sheet steel

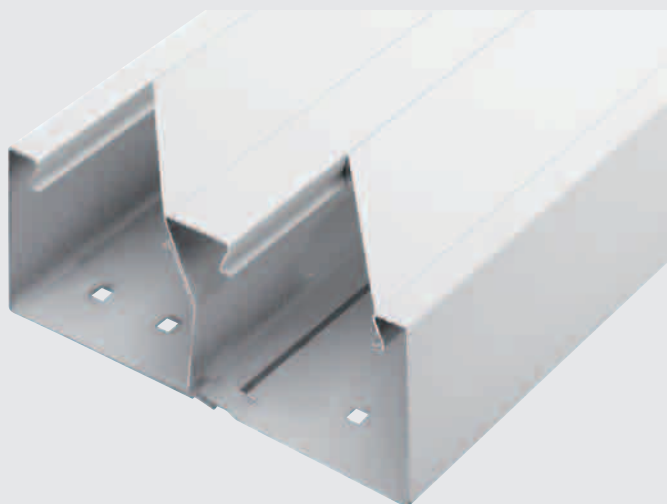

Material: Stahlblech sendzimirverzinkt.

Besondere Merkmale:

- Deckelbreite 76 mm, für frontbefestigte Einbaudosen, keine Geräteblenden erforderlich. Montagefreundliches Zubehör
- Farben: pulverbeschichtet in weiß RAL 9001 oder reinweiß RAL 9010, andere Farben auf Anfrage
- Lieferumfang: Unterteil mit Bodenlochungen (Abstand 250 mm) und Bodenlaschen (Abstand 250 mm) für Trennstegaufnahme; Länge 2 m; Deckel separat bestellen

Material: sheet steel sendzimir zinc-plated

Specific Features:

- Cover opening 76 mm, for socket Boxes which are fastened from the front, Cover sections not required. Easily assembled accessories
- Colours: powder-coated in white RAL 9001 or in pure white RAL 9010, other colours on request
- Extent of supply: base with perforated bottom (distance 250 mm), with tongues installed in the bottom for the insertion of dividers (distance 250 mm), length 2 m. Order covers separately

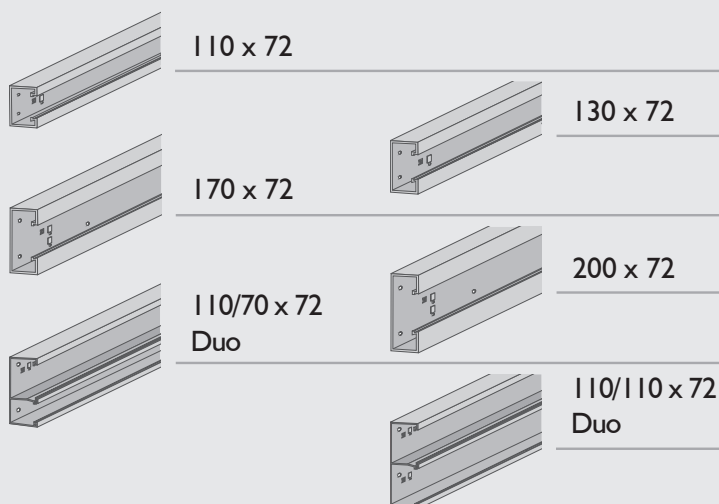

Wandanschlussblende / Wallcover

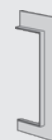

Typ Type	Farbe Colour	Artikel-Nr. Article-No.
110 x 72	RAL 9001	11873
110 x 72	RAL 9010	11874
130 x 72	RAL 9001	13873
130 x 72	RAL 9010	13874
170 x 72	RAL 9001	17873
170 x 72	RAL 9010	17874
200 x 72	RAL 9001	20873
200 x 72	RAL 9010	20874
110/70 x 72 Duo	RAL 9001	18873
110/70 x 72 Duo	RAL 9010	18874
110/110 x 72	RAL 9001	22873
110/110 x 72	RAL 9010	22874

Farbe Colour	Abmessungen Dimensions B x H / W x H	Länge Length	VE PU	Artikel-Nr. Article-No.	Artikel-Nr. / Article-No.				
					Außeneck Outside Corner	Inneneck Inside Corner	Flachwinkel Flat Corner	T-Stück T-piece	Endstück End Cap
RAL 9001	110 x 72	2 m	8	11373	11473	11573	11673	11677	11773
RAL 9010	110 x 72	2 m	8	11374	11474	11574	11674	11678	11774
RAL 9001	130 x 72	2 m	6	13373	13473	13573	13673	13677	13773
RAL 9010	130 x 72	2 m	6	13374	13474	13574	13674	13678	13774
RAL 9001	170 x 72	2 m	4	17373	17473	17573	17673	17677	17773
RAL 9010	170 x 72	2 m	4	17374	17474	17574	17674	17678	17774
RAL 9001	200 x 72	2 m	4	20373	20473	20573	20673	20677	20773
RAL 9010	200 x 72	2 m	4	20374	20474	20574	20674	20678	20774
RAL 9001	110/70 x 72 Duo	2 m	4	18373	18473	18573	18673	18677	18773
RAL 9010	110/70 x 72 Duo	2 m	4	18374	18474	18574	18674	18678	18774
RAL 9001	110/110 x 72 Duo	2 m	4	22373	22473	22573	22673	22677	22773
RAL 9010	110/110 x 72 Duo	2 m	4	22374	22474	22574	22674	22678	22774

Symbolische Darstellungen:

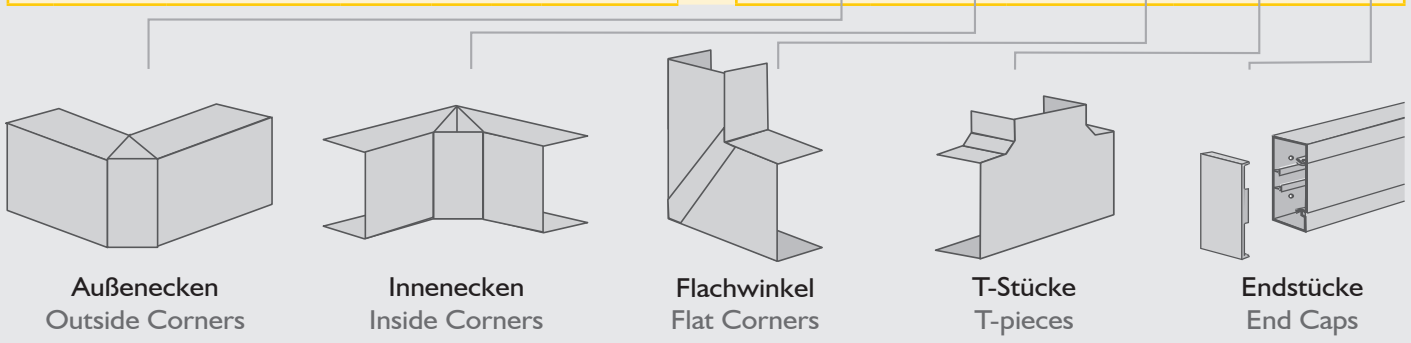

Stoßverbinder innen / Couplers, internal

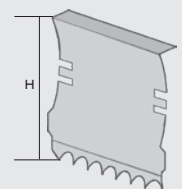

Typ Type	H	Material	Pro Stoßstelle benötigt Per joint required	VE PU	Artikel-Nr. Article-No.
Bauhöhe 72 / installation height 72	72	Federstahl / spring steel	2 Stück / pieces	20	30053

BRS-F, Stahlblech / BRS-F, made of sheet steel

Brüstungskanäle aus Stahlblech / Undersill Trunkings, sheet steel

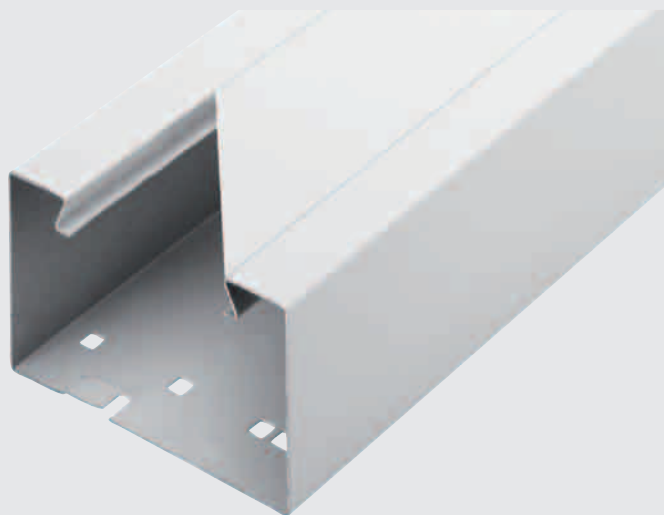

Material: Stahlblech sendzimirverzinkt.

Besondere Merkmale:

- Deckelbreite 76 mm, für frontbefestigte Einbaudosen, keine Geräteblenden erforderlich. Montagefreundliches Zubehör
- Farben: pulverbeschichtet in weiß RAL 9001 oder reinweiß RAL 9010, andere Farben auf Anfrage
- Lieferumfang: Unterteil mit Bodenlochungen (Abstand 250 mm) und Bodenlaschen (Abstand 250 mm) für Trennstegaufnahme; Länge 2 m; Deckel separat bestellen

Material: sheet steel sendzimir zinc-plated

Specific Features:

- Cover opening 76 mm, for socket Boxes which are fastened from the front, Cover sections not required. Easily assembled accessories
- Colours: powder-coated in white RAL 9001 or in pure white RAL 9010, other colours on request
- Extent of supply: base with perforated bottom (distance 250 mm), with tongues installed in the bottom for the insertion of dividers (distance 250 mm), length 2 m. Order covers separately

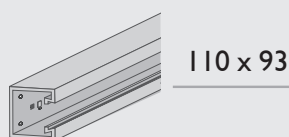

110 x 93

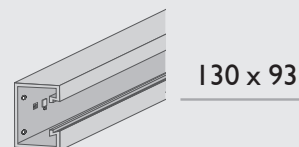

130 x 93

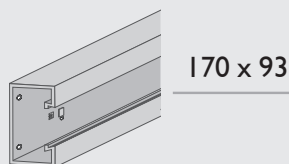

170 x 93

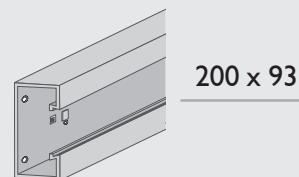

200 x 93

Wandanschlussblende / Wallcover

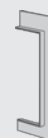

Typ Type	Farbe Colour	Artikel-Nr. Article-No.
110 x 93	RAL 9001	11894
110 x 93	RAL 9010	11895
130 x 93	RAL 9001	13894
130 x 93	RAL 9010	13895
170 x 93	RAL 9001	17894
170 x 93	RAL 9010	17895
200 x 93	RAL 9001	20894
200 x 93	RAL 9010	20895

Klammer / Clamp



Typ Type	Deckelöffnung Cover opening	Artikel-Nr. Article-No.
76	76 mm	10081

Farbe Colour	Abmessungen Dimensions B x H / W x H	Länge Length	VE PU	Artikel-Nr. Article-No.
RAL 9001	110 x 93	2 m	8	11394
RAL 9010	110 x 93	2 m	8	11395
RAL 9001	130 x 93	2 m	6	13394
RAL 9010	130 x 93	2 m	6	13395
RAL 9001	170 x 93	2 m	4	17394
RAL 9010	170 x 93	2 m	4	17395
RAL 9001	200 x 93	2 m	4	20394
RAL 9010	200 x 93	2 m	4	20395

Symbolische Darstellungen:

Artikel-Nr. / Article-No.				
Außeneck Outside Corner	Inneneck Inside Corner	Flachwinkel Flat Corner	T-Stück T-piece	Endstück End Cap
11494	11594	11694	11698	11794
11495	11595	11695	11699	11795
13494	13594	13694	13698	13794
13495	13595	13695	13699	13795
17494	17594	17694	17698	17794
17495	17594	17695	17699	17795
20494	20594	20694	20698	20794
20495	20595	20695	20699	20795

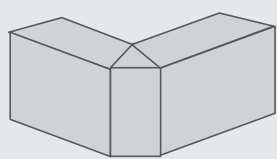

Außenecken
Outside Corners

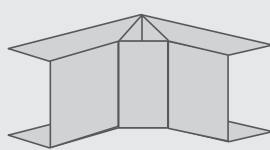

Innenecken
Inside Corners

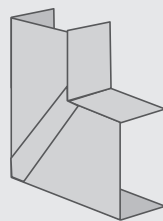

Flachwinkel
Flat Corners

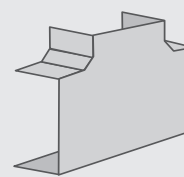

T-Stücke
T-pieces

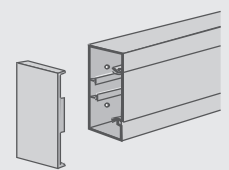

Endstücke
End Caps

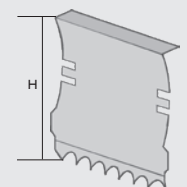

Stoßverbinder BR / Coupler BR

Typ Type	H	Material	Pro Stoßstelle benötigt Per joint required	Artikel-Nr. Article-No.
93	93 mm	Federstahl / spring steel	2 Stück / piece	30078

Allgemeines Zubehör / General Accessories

Halter für Lüftungslamellen / Holder for Ventilation Fins

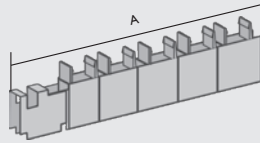

Typ Type	A	Material	Farbe colour	Artikel-Nr. Article-No.
125	125 mm	Kunststoff / plastic	RAL 9297	30030

Lüftungslamelle / Ventilation Fin

Aluminium pulverbeschichtet /
Aluminium powder-coated

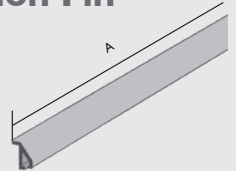

Typ Type	A	Farbe Colour	VE PU	Artikel-Nr. Article-No.
Lammelle / Fin	2 m	RAL 9010	100	30002
Lammelle / Fin	2 m	RAL 9001	100	30005

Verbindungsstift / Connection Pin

für Lüftungslamellen / for Ventilation Fins

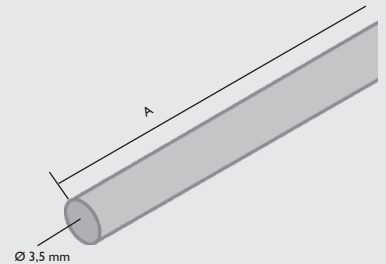

Typ Type	A	Farbe Colour	Pro Stoßstelle benötigt Per joint required	Artikel-Nr. Article-No.
Verbindungsstift / Connection Pin	30 mm	brüniert / gun-metal finish	1 Stück / piece	30019

Konsole für Lüftungslamellen / Bracket for Ventilation Fins

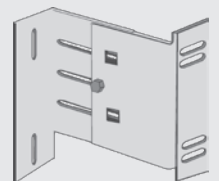

Typ Type	Verstellbarer Bereich Adjustable range	Artikel-Nr. Article-No.
55-77	55 - 77 mm	30073
65-93	65 - 93 mm	30074
80-123	80 - 123 mm	30075
115-185	115 - 185 mm	30076
175-275	175 - 275 mm	30077

Stahlblech, sendzimirverzinkt / Sheet steel, sendzimir zinc-plated

BR / BR 70 Zubehör / BR / BR 70 Accessories

Schraubenganitur M6x10 / Screw Set M6x10



Typ Type	Material Flanschmutter / Flange nut	Artikel-Nr. Article-No.
M 6 x 10	verzinkt / zinc-plated	307144

CEE Einbausatz / Installation Set

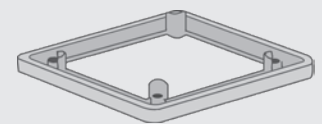

Typ Type	Für CEE mit Flansch For CEE with Flange	Artikel-Nr. Article-No.
Einbausatz / Installation Set	75 mm	9061

Deckel / Cover

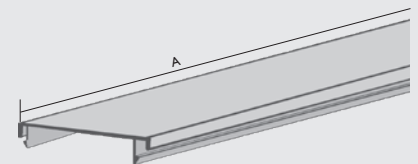

Typ Type	H	A	Farbe Colour	VE PU	Artikel-Nr. Article-No.
DBR 80	76 mm	2 m	RAL 9001	50	8800
DBR 80	76 mm	2 m	RAL 7035	50	8804
DBR 80	76 mm	2 m	RAL 9010	50	8805

Trennstege einfach / Divider single

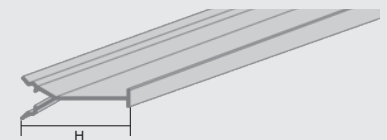

Typ Type	A	VE PU	Artikel-Nr. Article-No.
TS 65	2 m	80	9050
TS 110/210	2 m	80	9052
TS 130/170	2 m	80	8830

Einbaudosen BR / Socket Boxes BR

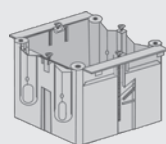

Typ F / Type F

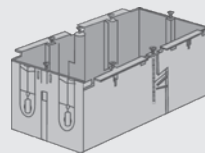

Typ G / Type G

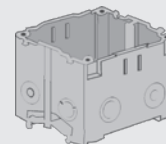

Typ B / Type B

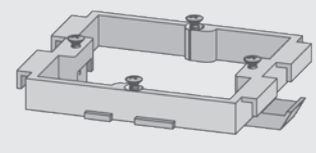

Geräteträger / Carrier

Typ Type	Einbaudose Socket Box	Höhe / Height in mm	Befestigung Fastening	VE PU	Artikel-Nr. Article-No.
F	1-fach / single	45	Front / frontal	40	9067
G	2-fach / double	45	Front / frontal	20	9068
B	1-fach / single	50	Boden / bottom	40	9060
	Geräteträger	-	Front / frontal	I	10350

BRS-F Zubehör / BRS-F Accessories

Einbaudosen BRS-F / Socket Boxes BRS-F

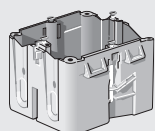

Typ A / Type A

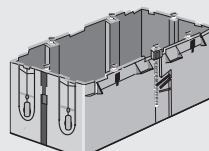

Typ E / Type E

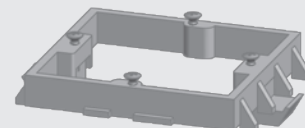

Geräteträger / Carrier

Typ Type	Einbaudose Socket Box	Höhe / Height in mm	Befestigung Fastening	VE PU	Artikel-Nr. Article-No.
A	1-fach / single	47	Front / frontal	40	9075
E	2-fach / double	45	Front / frontal	20	9078
	Geräteträger	-	Front / frontal	1	10351

Potentialausgleich für Deckel / Ground Connector for Cover



Typ Type	Material	Artikel-Nr. Article-No.
2,5 mm ²	Federstahl / spring steel	30080

Potentialausgleichsleitung / Voltage Equilizer Cable

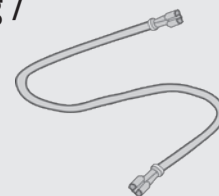

Typ Type	Länge Length	Artikel-Nr. Article-No.
2,5 mm ²	300 mm	30062

Stabilisierungsprofil für BRS-F 200 / Stabilisation profile for BRS-F 200

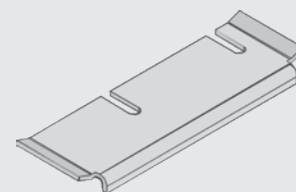

Typ Type	Material	Farbe Colour	Für For	Stück Piece	Artikel-Nr. Article-No.
Für / for BRS-F 200	Stahlblech / sheet steel	sendzimirverzinkt / sendzimir zinc-plated	200 + 110/100	2	30036
Für / for BRS-F 200	Stahlblech / sheet steel	verzinkt / zinc-plated	170 + 110/70	2	30035

Trennstege einfach / Divider single

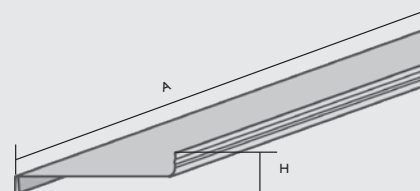

Typ Type	H	A	Material	Farbe Colour	VE PU	Artikel-Nr. Article-No.
45	45 mm	2 m	Stahl / steel	verzinkt / zinc-plated	50	10300
45 PVC	45 mm	2 m	PVC	grau / grey	50	10301
65	65 mm	2 m	Stahl / steel	verzinkt / zinc-plated	50	10302

Deckel / Cover

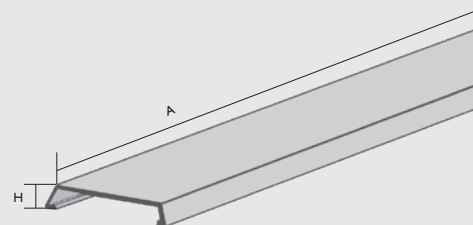

Typ Type	H	A	Material	Farbe Colour	VE PU	Artikel-Nr. Article-No.
40	40 mm	2 m	RAL 9001	Stahlblech / sheet steel	40	80011
40	40 mm	2 m	RAL 9010	Stahlblech / sheet steel	40	80014
76	76 mm	2 m	RAL 9001	Stahlblech / sheet steel	40	80001
76	76 mm	2 m	RAL 9010	Stahlblech / sheet steel	40	80004
76	76 mm	2 m	RAL 9001	PVC	40	80003
76	76 mm	2 m	RAL 9010	PVC	40	80002

Potentialausgleich, inkl. 3 Stück für Deckel / Earth connector, Sheet steel, sendzimir zinc-plated

„Lehnen Sie sich zurück!“



Fotografie, Grafik, Text, all rights reserved by MoS Media Group, BRD#TM, V111, LICATEC®

**„Sie haben den direkten
Kontakt zu Licatec
gefunden!“**



Licatec GmbH
Licht und Kabelführungssysteme
Alfred-Nobel-Str. 2-14
50226 Frechen
Germany
Tel.: +49 (0) 22 34 / 9 55 66 - 0
Fax: +49 (0) 22 34 / 9 55 66 - 955

Licatec GmbH
Leuchtenbau und Kabelführungssysteme
Erzstr. 7
09618 Brand-Erbisdorf
Germany
Tel.: +49 (0) 3 73 22 / 33 5 - 0
Fax: +49 (0) 3 73 22 / 25 13